

**Factors controlling initiation and orientation of the  
macrocotyledon in anisocotylous Gesneriaceae.**

**Edinb. J. Bot. 60: 467-482.**

**REFNO: 3405**

**KEYWORDS:**

**Chirita, Cotyledon, Development, Morphology, Seedling, Streptocarpus**

# EDINBURGH JOURNAL OF BOTANY

AN INTERNATIONAL JOURNAL OF PLANT  
SYSTEMATICS AND BIODIVERSITY

VOLUME 60, No.3

Dedicated to Bill Burt  
in celebration of his ninetieth birthday

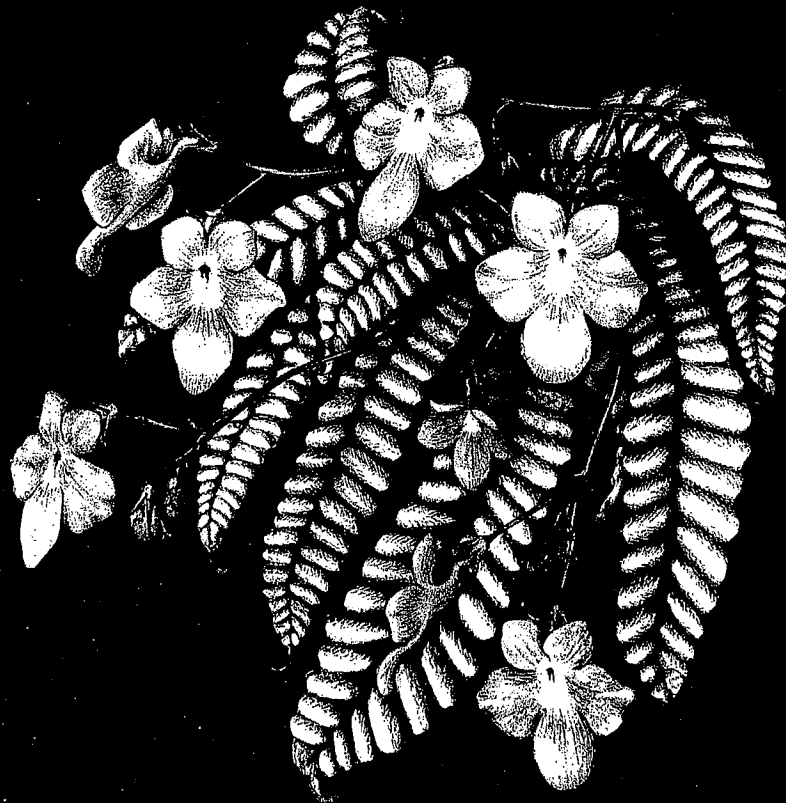

## FACTORS CONTROLLING INITIATION AND ORIENTATION OF THE MACROCOTYLEDON IN ANISOCOTYLOUS *GESNERIACEAE*

J. SAUEREGGER\* & A. WEBER\*

Anisocotyly, the prolonged meristematic growth of one of the two cotyledons, is a distinctive feature of *Gesneriaceae* subfam. *Cyrtandroideae*. The larger cotyledon, the macrocotyledon, often grows to resemble a normal foliage leaf, and in some taxa may be the only foliar organ of the plant. This raises a number of questions. Which cotyledon becomes the macrocotyledon? Is this pre-determined in the embryo or differentiated after germination? Which external factors such as gravity and light are involved? The observation that the macrocotyledons of unifoliate *Gesneriaceae* growing on steep rocks mostly point downwards suggests that gravity is involved, but it is not clear whether it plays an initial determinant role or merely later influences orientation. In order to identify possible controlling factors, several experiments were performed, mostly on material of *Chirita lavandulacea* and *Streptocarpus rexii*. All seedlings responded significantly to light, the cotyledon further from the light source becoming the macrocotyledon. Seedlings growing in inclined pots with the light source below the pots mostly developed an upper macrocotyledon. The explanation proposed is that this cotyledon receives more light when the two cotyledons unfold after germination. Later on, apparently due to gravity, *Chirita* seedlings showed re-orientation with the macrocotyledons ultimately pointing downwards, though in *Streptocarpus* no such downwards re-orientation was observed. This difference is probably correlated to a difference in hypocotyl structure. Our conclusion is that while light is the initial factor controlling macrocotyledon development, gravity may cause re-orientation in some species.

**Keywords.** Anisocotyly, *Chirita lavandulacea*, *Chirita micromusa*, clinostat, *Cyrtandroideae*, *Gesneriaceae*, gravitropy, gravity, light, macrocotyledon, microcotyledon, photomorphogenesis, red light spectrum, *Streptocarpus rexii*.

### INTRODUCTION

The seedlings of dicotyledons normally have two cotyledons of equal size and growth habit. Exceptions mainly involve plants in which fusion or reduction results in seedlings with a single cotyledon or cotyledons of different size (Sargant, 1903; Metcalfe, 1936; Hill, 1938; Förster, 1997). Anisocotyly, as defined by Fritsch (1904, 1920), however, applies to plants where one of the initially equal cotyledons, the macrocotyledon, continues growth disproportionately while the other remains minute and non-functional. This peculiar character is found only in Old World *Gesneriaceae* and was used by Burt (1963) for re-defining *Gesneriaceae* subfam.

\* Institute of Botany, University of Vienna, Rennweg 14, A-1030 Vienna, Austria.

*Cyrtandroideae*. Detailed information on seedling morphology in particular taxa can be found in, for example, Fritsch (1904), Hill (1938), Schenk (1942), Burt & Woods (1958), Burt (1963), Jong (1970), Jong & Burt (1975), Weber (1975, 1978) and Imaichi *et al.* (2001).

Surprisingly little is known about the causal and controlling factors of anisocotily. Anisocotily, as such, is genetically fixed, but no consensus has been reached on whether the macro- and microcotyledons are genetically controlled or differentiate after germination. Based on the observation that the two cotyledons of *Streptocarpus* Lindl. are often unequal in the embryo, authors such as Hielscher (1883), Pischinger (1902) and Schenk (1942) tended to believe that the macrocotyledon is differentiated before germination. In contrast, Oehlkers (1923) reported that the cotyledons of *Monophyllaea horsfieldii* R. Br. are equal at germination. The same conclusion was reached by Tsukaya (1997) based on excision experiments and on monitoring DNA synthesis in the meristematic regions associated with the cotyledons. Tsukaya also carried out gravity-based experiments, but finding no significant effects, he concluded that anisocotily was the result of competition between the two cotyledons.

The present study resulted from the observation that in unifoliolate *Gesneriaceae* growing on steep cliffs the macrocotyledons regularly point downwards (see illustrations in Hilliard & Burt, 1971: pls 8d, 10b, 14a; Burt, 1978, pl. 1; Weber & Kiew, 1984; Kohyama & Hotta, 1986: fig. 2; Okada, 1990: figs 1, 2). This suggests the involvement of gravity. However, the question remained open whether gravity is the decisive factor, i.e. whether it controls which of the initially equivalent cotyledons becomes the macrocotyledon, or whether it influences only the orientation of the macrocotyledon after it has been differentiated.

A series of experiments was conducted to investigate which mechanism or factors apply and whether there is uniformity in seedling behaviour. The experiments were designed specifically to test the effect of gravity, light direction and spectral fraction on the differentiation and orientation of the macrocotyledon.

## I. MATERIALS

For technical reasons such as ease of germination, robustness of testa during sterilization, and availability of the necessary seed quantities, two species were selected for all the experiments. Seeds of *Chirita lavandulacea* Stapf were obtained from the Botanical Garden Greifswald, Germany (Index seminum 93/126, Code: A 05, acc. no. 03447-70, 1994) and from the Botanical Garden Mainz, Germany (1995); those of *Streptocarpus rexii* (Hook.) Lindl. came from the Botanical Garden Vienna, Austria (1994, 1995, originally collected by H. Kurzweil in South Africa). For some additional experiments *Chirita micromusa* B.L. Burt, *C. caliginosa* C.B. Clarke and *C. sericea* Ridl. were used, these species having been cultivated for many years at the Botanical Garden Vienna. All the experiments were carried out in 1996 at the Institute of Botany, University of Vienna.

## II. PRELIMINARY EXPERIMENTS

### Methods

Seeds of *Chirita lavandulacea* and *Streptocarpus rexii* were sown in pots on compost. For each species, half of the pots were kept horizontal, while the other half were inclined at c.60°. Illumination was by natural daylight.

### Results

After several weeks the seedlings in the horizontal pots showed  $\pm$  random distribution of macrocotyledons, while in the inclined pots the macrocotyledons pointed predominantly downwards.

### Discussion

This is exactly as found in nature: carpets of seedlings on steep rock walls (e.g. species of *Chirita*, *Epithema* Blume, *Monophyllaea* R. Br., etc. on limestone cliffs) almost always grow with their macrocotyledons pointing downwards.

## III. CONTROL: HORIZONTAL SUBSTRATE AND VERTICAL LIGHT (IN PETRI DISHES)

This experiment was conducted to establish the suitability of the system for some special experiments under controlled conditions, and to observe seedling morphology under these conditions.

### Methods

Before sowing, the seeds were surface sterilized for 8 minutes in a saturated solution of  $\text{Ca}(\text{OCl})_2$  and rinsed three times in deionized distilled water. They were then sown in Petri dishes with agar (MS salt: 4.3g/l, sucrose 30g/l, myo-Inositol 0.1g/l, MES 0.5g/l, agar 9g/l; pH 5.7 adjusted with KOH). The Petri dishes were kept horizontal, with a vertical light source (Philips 6455 Cool Beam FPD - B 8, 12V, 75W, 25°) 1m above, set to a 14 hour day-length. Seedling growth was observed and documented by photographs at 2-day intervals for 2-3 months.

### Results

*Chirita lavandulacea*. The first evidence of germination, c.8 days after sowing, was rupturing of the testa at the hilar end through expansion of the hypocotyl. Within one day the hypocotyl tip bent downwards gravitropically. At the base of the hypocotyl, just above the root tip, rhizoids ('myzotriches', Haccius & Troll, 1961)

grew out, by which the seedlings became anchored to the substrate. The hypocotyl expanded until the cotyledons emerged from the seed, and shortly thereafter the two equal cotyledons unfolded slowly, in synchrony with the straightening of the hypocotyl. The fully expanded cotyledons were about 1mm × 1mm. At this stage, 10 days after sowing, it was not possible to distinguish between the cotyledons, even under a stereo-microscope. About 2–5 days later, anisocotily became apparent and differences between the micro- and macrocotyledon became obvious to the naked eye. Other distinguishing features were observable under the microscope; in particular, the bases of the two cotyledons were distinctly different. Of particular interest were the more prominent and numerous hairs on the macrocotyledon, similar to the indumentum of normal foliage leaves. Even at higher magnification a shoot apical meristem was not apparent, either as a concavity or a groove. The hypocotyl was usually not twisted, and elongated without turning. In general, the two cotyledons were opposite and at the same height; in only two out of c.40 seedlings was the macrocotyledon significantly above the microcotyledon. No preferential direction of the macrocotyledons was observed; orientation was simply at random.

*Streptocarpus rexii*. In general, germination was similar to that of *Chirita lavandulacea*, but the seedlings were more compact, superficially succulent and dark green; the tiny roots were slightly red, probably due to anthocyanins. Anisocotily became apparent between 8 and 40 days after germination, with no obvious preference in orientation of the macrocotyledons.

#### Conclusion

The random orientation of the cotyledons is the same as for seedlings grown in horizontal pots in the preliminary experiments (see under II above).

### IV. GRAVITY AND LIGHT DIRECTION

#### A. VERTICAL SUBSTRATE – LIGHT HORIZONTAL (IN PETRI DISHES)

##### Methods

This was set up as in the control, but with Petri dishes vertical and the direction of light horizontal.

##### Results

*Chirita lavandulacea* and *Streptocarpus rexii*. Because of the vertical substrate many seeds and seedlings were lost and these experiments did not prove very successful. The remaining seedlings showed random distribution as in the control (III).

### Conclusion

As the vertical position of the Petri dishes did not influence macrocotyledon orientation in either species, gravity is apparently not an essential factor in macrocotyledon differentiation.

#### B. INCLINED SUBSTRATE - LIGHT BELOW HORIZONTAL (IN POTS)

This experiment tested the effect of gravity combined with an almost inverted light source (Fig. 1A). Under natural conditions, with seedlings growing on an inclined surface and solar illumination from above, the macrocotyledons mostly point downwards, away from the light (see also preliminary experiments with inclined pots). If light, rather than gravity, is the controlling factor, illumination from below the seedlings (Figs 1, 6B) should have the opposite effect, with the upper cotyledons becoming macrocotyledons. In both cases, the natural system as well as our experiment, the influence of gravity is the same, and possible secondary orientation effects should be detected. Initial cotyledon differentiation can thus be separated from later orientation.

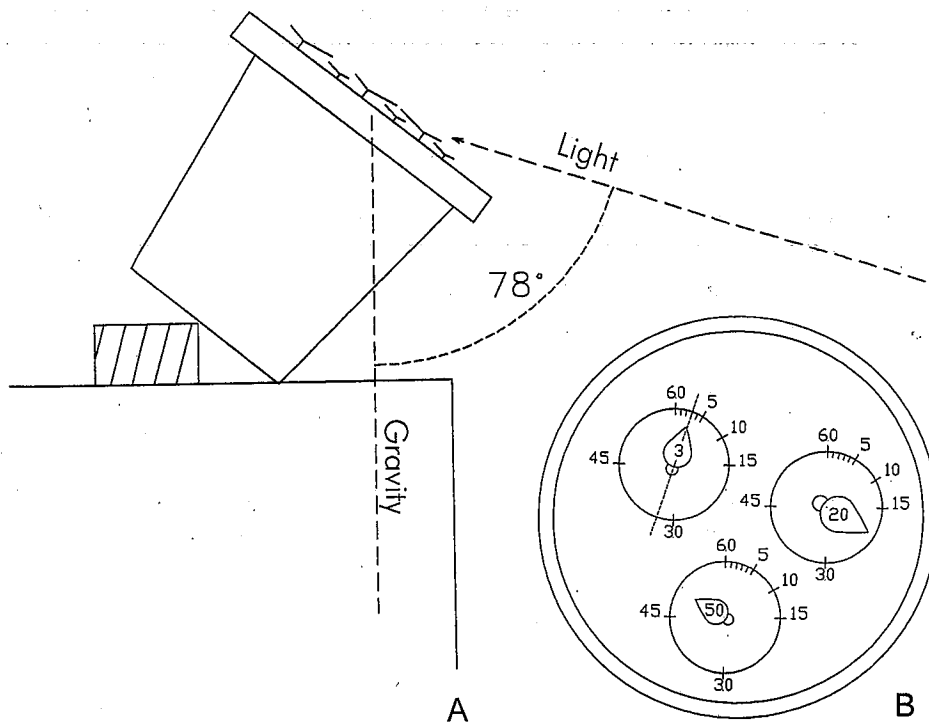

FIG. 1. A, Experiment to investigate the effects of a below-horizontal light source coupled with gravity. B, Record of seedling orientation; the macrocotyledons point to a 3, 20 and 50 minute position on a clock-face.

### Methods

The seeds were sown in compost and the pots held at 60° to the horizontal, with the light source positioned 12° below the horizontal, and distance and technical data as in the control. The germination and development of the seedlings were documented by colour photographs at 2-day intervals, starting 2 weeks after sowing, over a period of 9–10 weeks for *Streptocarpus* and *Chirita*, respectively. Based on the photographs, the orientation of the macrocotyledons was recorded numerically as minutes on a clock-face (1 minute = 6° of arc), starting 'away' from the light source (12 o'clock position) (Fig. 1B).

In Figs 2, 4 and 5 the number of seedlings becoming orientated to a certain 'minute position' is shown both by a figure and by the length of the bar.

### Results

These experiments proved the most conclusive and the results are thus described in greater detail.

*Chirita lavandulacea*. When anisocotly became apparent, 80% of the seedlings developed a macrocotyledon in the semicircle away from the light source, and 90% of those were in a narrower, 20 minute sector (50–10 minutes, Fig. 2A). The mean value for all seedlings was 59 minutes ( $s=11.65$ ), almost directly opposite the light source.

Over time, however, this value shifted towards 30 minutes, and was 29 minutes ( $s=4.56$ ) at 67 days after sowing (Fig. 2D). In other words, the initially  $\pm$  upwards-pointing macrocotyledons had turned around and mostly occupied a position pointing downwards (Fig. 7A).

This conspicuous change in macrocotyledon orientation is illustrated for three selected seedlings in Fig. 3. This shows a re-orientation of the macrocotyledon along the gravitational gradient, with the most dramatic twisting occurring within 2 weeks after anisocotly was first observable. In seedling C, the macrocotyledon first occupied a 40 minute position, then turned upwards to a 50 minute position and finally moved progressively downwards. This indicates that gravity becomes important with increasing age of the seedling, and that in the early stages there is only orientation towards better light capture.

*Chirita micromusa*. To confirm the results obtained for *C. lavandulacea*, similar experiments were carried out on *Chirita micromusa*. The results (Fig. 4) proved to be very similar.

*Streptocarpus rexii*. Unambiguous anisocotly was apparent 24 days after germination and 38 days after sowing. As in *Chirita*, the cotyledons away from the light source developed into macrocotyledons; 76% of seedlings showed this phenomenon at 38 days (Fig. 5A), increasing to 85% by 49 days (Fig. 5B). The mean value was 5 minutes ( $s=11.6$ ) at 38 days, and, unlike *Chirita*, did not change markedly, still



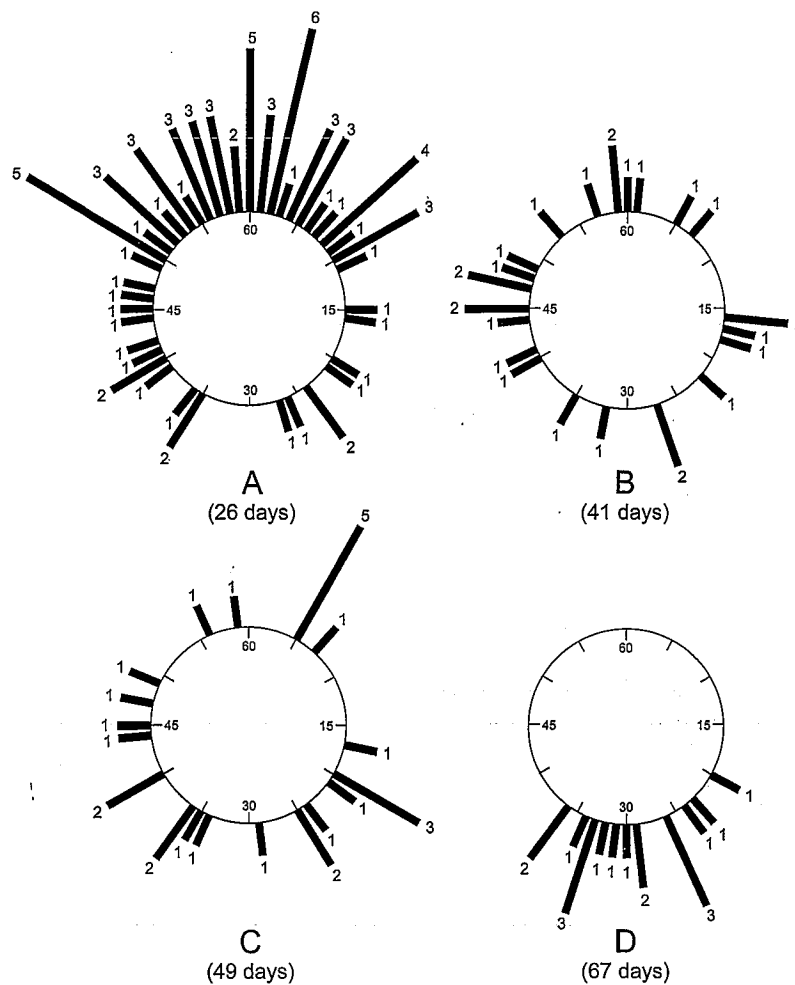

FIG. 2. *Chirita lavandulacea*. Orientation of macrocotyledons over time (days after sowing) under the effects of a below-horizontal light source coupled with gravity.

being directly away from the light source (1 minute;  $s=6.8$ ) at the end of the experiment (Figs 5C, 7B).

It is notable that any seedlings which were not directly illuminated, especially those shaded by the lower rim of the pot, did not develop a macrocotyledon. At the end of the experiment all these seedlings were dead.

#### Conclusions

These experiments showed that in all species it is mainly the upper cotyledons which develop into a macrocotyledon, when the light source is lower than the pot. In

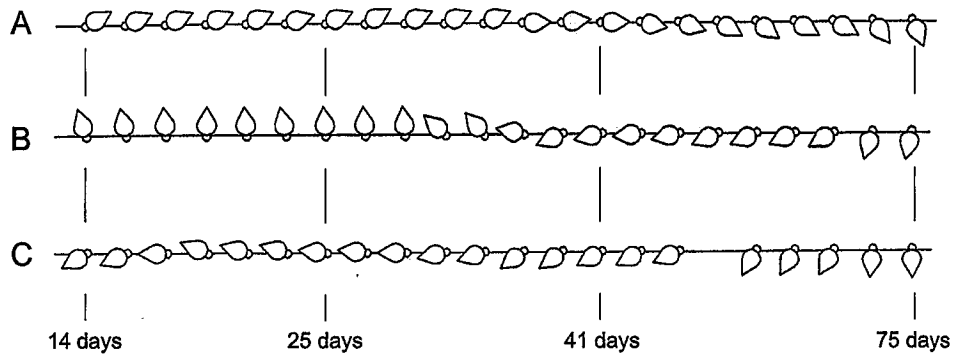

FIG. 3. Re-orientation of three *Chirita lavandulacea* seedlings (A, B, C) over time under the effects of a below-horizontal light source coupled with gravity, recorded at intervals of 2 or 3 days (increase in macrocotyledon size not shown).

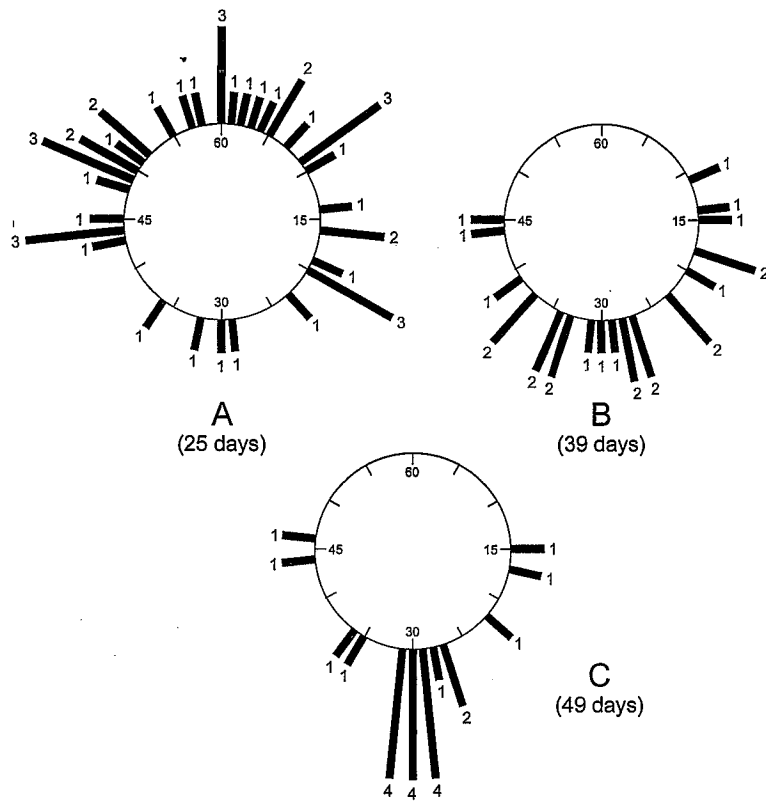
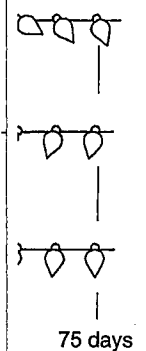

FIG. 4. *Chirita micromusa*. Orientation of macrocotyledons over time (days after sowing) under the effects of a below-horizontal light source coupled with gravity.

Fi  
ur  
  
St  
lig  
is  
to  
se  
re  
pe  
  
bo  
a  
sp  
tv  
co  
li  
li  
co  
ro



one under the  
als of 2 or 3

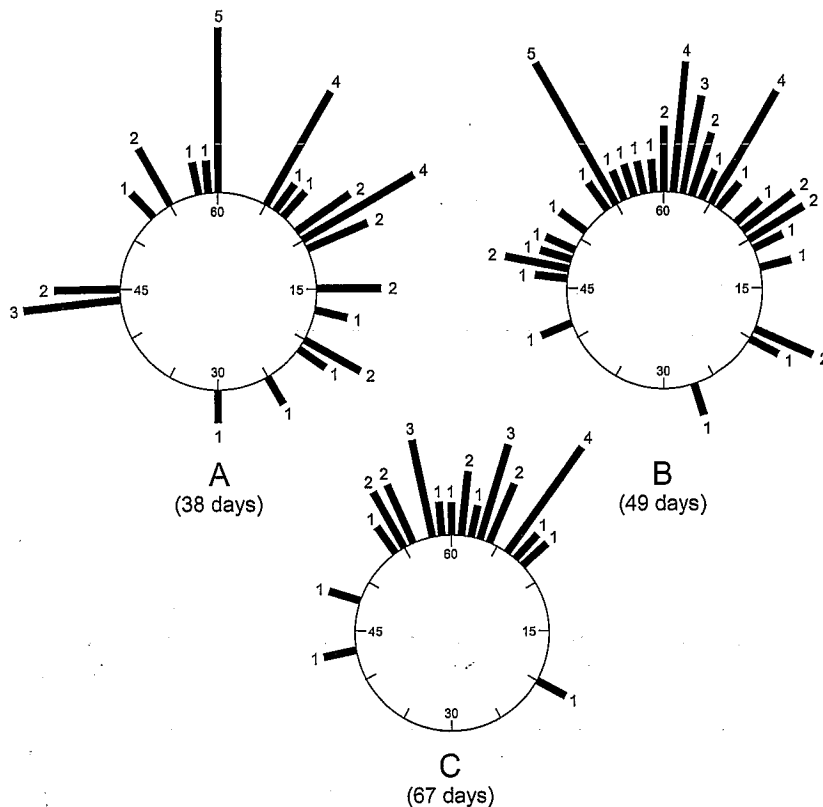

FIG. 5. *Streptocarpus rexii*. Orientation of macrocotyledons over time (days after sowing) under the effects of a below-horizontal light source coupled with gravity.

*Streptocarpus* the seedlings subsequently showed slight re-alignment parallel to the light, with some macrocotyledons finally approaching the 12 o'clock position. This is clearly the position of maximum light capture. In *Chirita* too, slight rotation towards better light capture was initially observed in particular seedlings (Fig. 3, seedling C), but later, apparently through the influence of gravity, the seedlings re-orientated very strongly with the macrocotyledons moving towards the 6 o'clock position.

That the cotyledon further from the light always becomes the macrocotyledon can be explained as follows. Under natural conditions, immediately after germination on a vertical substrate, the unfolding cotyledons are still of equal size and show random spatial orientation. In the process of unfolding it is almost inevitable that one of the two will be more directly exposed to sunlight than the other. The lamina of the lower cotyledon, being further from the light source, is then better positioned to catch light. This then becomes the macrocotyledon (Fig. 6A). When, as in our experiment, light comes from below the seedlings, the upper cotyledon becomes the macrocotyledon (Fig. 6B). The same may occur in nature, when seedlings grow under rocks or in caves. This has been observed in *Streptocarpus decipiens* and *S. pusillus*

ter sowing)

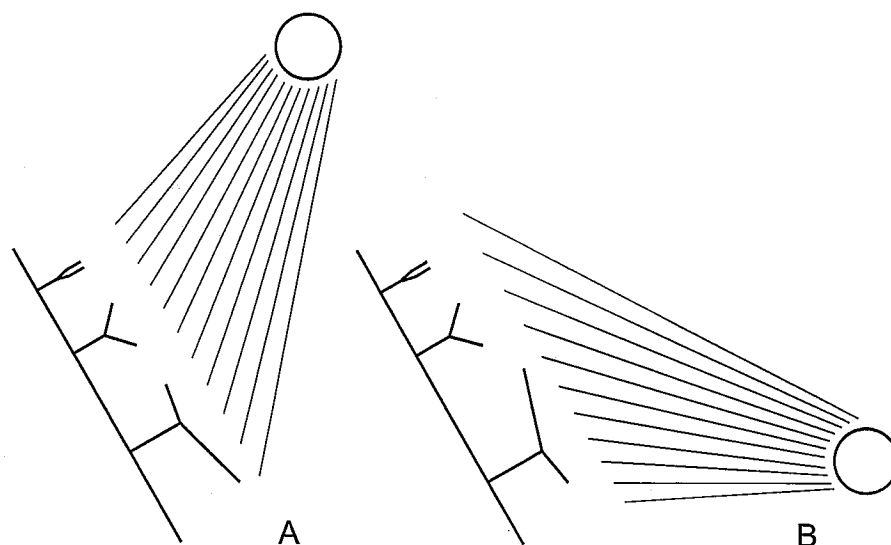

FIG. 6. Proposed explanation of macrocotyledon differentiation under (A) normal conditions (light from above) and (B) experimental conditions (light from below); in A the lower cotyledon becomes the macrocotyledon; in B it is the upper cotyledon.

growing in sheltered damp crevices or horizontal cracks under overhangs on sandstone outcrops. In these situations, the cotyledons are also positioned in an upright, almost vertical position to maximize light capture (B.L. Burt & O.M. Hilliard, pers. comm.).

In *Streptocarpus* the macrocotyledons remain  $\pm$  in this position after differentiation or may make slight adjustments towards better light capture. Gravity does not seem to play a role, as no downwards movements could be observed. Major movements are probably not possible because of the short and stout 'petiolode'. In contrast, *Chirita* seedlings are able to rotate through  $180^\circ$  and more, apparently by twisting and curving of the long, thin hypocotyl. This re-orientation of the macrocotyledon into a stable 'hanging' position, suitable for maximizing light capture from above, is apparently strongly influenced by gravity.

#### V. NEUTRAL GRAVITY - HORIZONTAL LIGHT (IN PETRI DISHES)

This experiment was designed to investigate the possible effect of gravity on seedling development under conditions of neutral gravity ('omnilateral gravistimulation' of Elfving, 1883, and Sievers & Hensel, 1981).

#### Methods

The seeds were pre-treated and sown as described for the control. For each experiment a Petri dish was mounted vertically on a clinostat with slow rotation

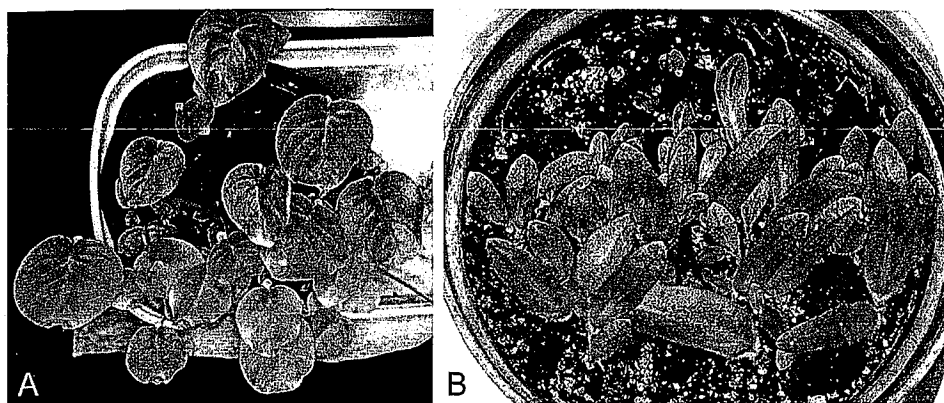

FIG. 7. Seedlings of (A) *Chirita lavandulacea*, 71 days after sowing, and (B) *Streptocarpus rexii*, 82 days after sowing, with a below-horizontal light source coupled with gravity. Note different orientation of the macrocotyledons.

speeds of 0.8 and 2rpm. Illumination was horizontal as in experiment IV(A). To exclude the influence of centrifugal forces, just a few seeds were fixed in the centre of the Petri dish.

#### Results

*Chirita lavandulacea*. At 0.8rpm, 16 of the 17 seedlings (94%) were isocotylous, developing two macrocotyledons. Only in a single seedling was cotyledon differentiation observed. Initially, germination proceeded as in the control seedlings. The only difference observed was that the radicles grew parallel to the horizontal light and into the agar. In the second experiment at 2rpm, all 12 seedlings produced two macrocotyledons.

*Chirita caliginosa* and *C. sericea*. Under the same experimental conditions most seedlings of these species developed in a normal, anisocotylous manner.

*Streptocarpus rexii*. All seedlings showed unambiguous anisocotyly similar to the control, though slight differences were observed in general habit. The whole root was dark red except for the tip; the hypocotyl was light green; the cotyledons appeared darker green than in the control, and the hairs on the macrocotyledons were more numerous and longer.

#### Conclusion

The development of two equal cotyledons in *Chirita lavandulacea* under neutral gravity is most remarkable. However, no generalization can be made as in the other *Chirita* species investigated, and in *Streptocarpus*, most seedlings developed in the

typical anisocotylous manner. More specific studies are needed to understand the effect of gravity neutralization and the differing results.

## VI. RED LIGHT

This experiment investigated the effects of a specific region of the light spectrum (red light wavelengths of 590–750nm) on seedling growth.

### *Methods*

Plastic red light filters were fixed to the lids of the Petri dishes; otherwise the set-up was as in the control.

### *Results*

*Chirita lavandulacea*. Germination and growth under red light led to the formation of anisocotylous seedlings with distinctly larger basal lobes than in the control, and the cotyledons were often recurved. Because of their larger bases, the macrocotyledons sometimes overlapped the microcotyledons.

*Streptocarpus rexii*. The seedlings were predominantly weak and appeared etiolated with long, thin hypocotyls. The cotyledons remained very small, obviously due to delayed development, and any differences between them were barely observable.

### *Conclusion*

Red light seems to have different, species-specific effects: enhancement of anisocotily in *Chirita lavandulacea* and inhibition in *Streptocarpus rexii*. Further experiments are needed to interpret these results more fully.

## CONCLUDING REMARKS

The present results clearly support post-germination differentiation of the macrocotyledon. This agrees with the findings of Oehlkers (1923) and Tsukaya (1997), who both studied seedlings of *Monophyllaea horsfieldii*. Based on excision experiments, Oehlkers (1923) concluded that the two cotyledons are physiologically equivalent at germination and shortly thereafter. If the macrocotyledon was removed early (soon after differentiation), the remaining cotyledon was then able to develop into a macrocotyledon. Recently, Tsukaya (1997) demonstrated very elegantly the presence of meristems at the base of both cotyledons by monitoring DNA synthesis. He provided clear evidence that both cotyledons have equal potential for continuous growth after germination and that the timing of macrocotyledon differentiation is not strictly programmed. Based on these excision experiments,

Tsukaya proposed a competition theory, suggesting that the enlarging cotyledon suppressed growth of the other. 'Cotyledons compete with one another and one finally inhibits the further growth of the other, perhaps winning the competition as a result of the influence of some environmental factor' (Tsukaya, 1997: 1279). Rosenblum & Basile (1984) demonstrated that exogenously applied phytohormones can affect the development of cotyledons in *Streptocarpus* seedlings. Application of cytokinins (benzyladenine, BA) resulted in the formation of two macrocotyledons, similar to seedlings grown in neutral gravity. Suppression of macrocotyledon expansion was observed after treatments with both gibberellin (GA<sub>3</sub>) and auxin (indole acetic acid, IAA).

The experiments described under IV(B) (light source below the pot, the upper cotyledons becoming macrocotyledons) provide evidence that light plays a key role in the anisocotyledonous development of *Gesneriaceae* seedlings. This can be easily combined with Tsukaya's competition theory. When the two cotyledons unfold, the one that receives more light gains a physiological advantage. Light enables photosynthesis and growth (production of additional cells), and stimulates the production of growth hormones, probably including those which suppress growth of the microcotyledon. This suppression finally leads to irreversible anisocotyly.

Tsukaya found that gravity did not influence macrocotyledon differentiation, and the same result was obtained in the present study. In the experiments described under IV(A) (Petri dishes vertical, light horizontal) the macrocotyledons were randomly distributed, with no preference for downward orientation.

In experiments investigating the effect of gravity on germination and root growth, slow rotating clinostats are often used (Elfving, 1883; Sievers & Hensel, 1981). Their advantage is the provision of 'omnilateral' gravity without any harmful centrifugal forces (Shen-Miller *et al.*, 1968; Sobick & Sievers, 1979). The situation is comparable to the agravic conditions in space (Thimann, 1968). Under such conditions almost all seedlings of *Chirita lavandulacea* formed two macrocotyledons. In this species, suppression of the macrocotyledon is apparently neutralized under such conditions. However, as this did not occur in other species of *Chirita* and *Streptocarpus*, these results cannot be generalized. The persistence of anisocotyly in the latter species indicates a mechanism controlling suppression of the microcotyledon which is different from that observed in *Chirita lavandulacea*. As certain fundamental plant responses, for example the negative geotropic response of hypocotyls, appear to be coupled to gravity and light (Liscum & Hangarter, 1993), the responses of leaves and other aerial organs may not be adequately investigated using clinostats. Furthermore, plants are known to possess sensors capable of detecting other factors associated with rotation; this may affect their responses in the clinostat (Krikorian & Levine, 1991).

Once macrocotyledon development in *Streptocarpus rexii* seedlings had been induced with light below horizontal, only slight subsequent re-alignment closer to the light gradient was observed, but never any re-orientation along the gravitational gradient. This may be because the developing macrocotyledon is nearly sessile,

having a short 'petiolode' too rigid to allow secondary spatial shifts or passive gravitational responses. *Chirita lavandulacea* seedlings, however, displayed a clear response by re-orientating along the gravitational gradient. This re-orientation began 4 weeks after sowing, just after the identity of the macrocotyledon was noted, and when seedlings were still relatively small. This probably excludes any passive gravitational effect. Thus, an active growth process may be assumed, resulting in turning of the cotyledon, apparently by twisting (differential growth) or curving of the hypocotyl, or both combined, not unlike flower resupination.

The negative geotropic reaction of plants, for example the positioning of hypocotyls, is known to be affected by red light (Mohr & Pichler, 1960). However, applying exclusively red light did not change anisocotyly in *Chirita*, though it had some inhibitory effect on cotyledon development in *Streptocarpus*. Though *Chirita lavandulacea* seedlings developed more vigorously, the macrocotyledons were also larger than under white light. It is possible that development of the macrocotyledon is linked to the phytochrome system, thus promoting growth (Liscum & Hangarter, 1993).

In the present study an attempt was made to identify the factor which determines one of the two cotyledons to become the accrescent cotyledon after germination. We conclude that light is the key factor and that gravity, depending on the species and morphological features (hypocotyl structure), may or may not play a role in secondary orientation of the macrocotyledon. This simple result raises many questions, with regard both to its ecological significance and the physiological background. Beyond the considerations of Burt (1970) that the rapid elaboration of photosynthetic tissue in the single cotyledon may compensate for scanty food reserves in the small seeds, we still know very little about the adaptive-functional significance of anisocotyly, and the part it may have played in making the *Cyrtandroideae* such a large and successful group of *Gesneriaceae*. Regarding physiology, almost nothing is known at present about light receptors, the involvement of the phytochrome system, the active light spectrum, the response to different light intensities, the limits of light signal reception and the role and interplay of phytohormones. The present study can be regarded as only a first step. In our opinion, the seedlings of anisocotylous *Gesneriaceae* could serve as most promising model systems for physiological studies and provide new insights into differentiation and growth processes in plants.

#### ACKNOWLEDGEMENTS

The authors are indebted to Professor Dr Helmuth Horvath (Institute of Experimental Physics, University of Vienna) for help with the clinostat experiments, and to Professor Dr Robert Kartusch (Institute of Ecology and Nature Conservation, University of Vienna) for advice on the experiments with different light spectra. Dr Helmut Saueregger helped with statistical aspects. Special thanks go to Dr Michael Möller (Royal Botanic Garden Edinburgh), who translated, condensed and improved a provisional German version of the paper. Further improvements were suggested by



Dr Crinan Alexander and Dr Louis Ronse DeCraene (both Royal Botanic Garden Edinburgh), and an anonymous reviewer. Mag. Susanne Pamperl is thanked for the electronic preparation of Figs 2 and 4–6.

## REFERENCES

- BURTT, B. L. (1963). Studies in the Gesneriaceae of the Old World. XXIV. Tentative keys to tribes and genera. *Notes Roy. Bot. Gard. Edinburgh* 24: 205–220.
- BURTT, B. L. (1970). Studies in the Gesneriaceae of the Old World XXXI: Some aspects of functional evolution. *Notes Roy. Bot. Gard. Edinburgh* 30: 1–10.
- BURTT, B. L. (1978). Studies in the Gesneriaceae of the Old World. XLV. A preliminary revision of *Monophyllaea*. *Notes Roy. Bot. Gard. Edinburgh* 37: 1–59.
- BURTT, B. L. & WOODS, P. J. B. (1958). Studies in the Gesneriaceae of the Old World. XIV. The seedling stages of *Aeschynanthus*. *Notes Roy. Bot. Gard. Edinburgh* 21: 315–317.
- ELFVING, F. (1883). Ueber das Verhalten der Grasknoten am Klinostat. *Oefvers. Förh. Finska Vetensk.-Soc.* 26: 107–111.
- FÖRSTER, P. (1997). Die Keimpflanzen der Tribus Ranunculeae DC. und der Tribus Adonideae Kunth (Ranunculaceae). *Flora* 192: 133–142.
- FRITSCH, K. (1904). *Die Keimpflanzen der Gesneriaceen. Mit besonderer Berücksichtigung von Streptocarpus, nebst vergleichenden Studien über die Morphologie dieser Familie.* Jena: Fischer.
- FRITSCH, K. (1920). Über den Begriff der Anisokotylie. *Ber. Deutsch. Bot. Ges.* 38: 69–73.
- HACCIUS, B. & TROLL, W. (1961). Über die sogenannten Wurzelhaare von *Drosera* und *Cuscuta*-Arten. *Beitr. Biol. Pflanzen* 36: 138–157.
- HIELSCHER, T. (1883). Anatomie und Biologie der Gattung *Streptocarpus*. *Beitr. Biol. Pflanzen* 3: 1.
- HILL, A. W. (1938). The monocotylous seedlings of certain Dicotyledons. With special reference to the Gesneriaceae. *Ann. Bot.* 2: 127–145.
- HILLIARD, O. M. & BURTT, B. L. (1971). *Streptocarpus: An African Plant Study.* Pietermaritzburg: University of Natal Press.
- IMAICHI, R., INOKUCHI, S. & KATO, M. (2001). Developmental morphology of one-leaf plant *Monophyllaea singularis* (Gesneriaceae). *Pl. Syst. Evol.* 229: 171–185.
- JONG, K. (1970). *Developmental aspects of vegetative morphology in Streptocarpus.* PhD thesis, University of Edinburgh.
- JONG, K. & BURTT, B. L. (1975). The evolution of morphological novelty exemplified in the growth patterns of some Gesneriaceae. *New Phytol.* 75: 297–311.
- KOHYAMA, T. & HOTTA, M. (1986). Growth analysis of Sumatran *Monophyllaea* possessing only one leaf throughout perennial life. *Pl. Sp. Biol.* 117–125.
- KRIKORIAN, A. D. & LEVINE, H. G. (1991). Growth and development. VIII: Development and growth in space. *Pl. Physiol.* 10: 491–555.
- LISCUM, E. & HANGARTER, R. P. (1993). Genetic evidence that the red-absorbing form of phytochrome b modulates gravitropism in *Arabidopsis thaliana*. *Pl. Physiol.* 103: 15–19.
- METCALFE, C. R. (1936). An interpretation of the morphology of the single cotyledon of *Ranunculus ficaria* based on embryology and seedling anatomy. *Ann. Bot.* 50: 103–120.
- MOHR, H. & PICHLER, I. (1960). Der Einfluß hellroter und dunkelroter Strahlung auf die geotropische Reaktion der Keimlinge von *Sinapis alba* L. *Planta* 55: 57–66.

- OEHLKERS, F. (1923). Entwicklungsgeschichte von *Monophyllaea horsfieldii*. *Beih. Bot. Zentralblatt. I. Abt.* 39: 128-151.
- OKADA, H. (1990). A natural hybrid of *Monophyllaea* (Gesneriaceae) in the tropical rain forest of West Sumatra. *Pl. Syst. Evol.* 169: 55-63.
- PISCHINGER, F. (1902). Über Bau und Regeneration des Assimilationsapparates von *Streptocarpus* und *Monophyllaea*. *Sitzungsber. Kaiserl. Akad. Wiss. Wien, Math.-Naturwiss. Kl.* 111: 278-302.
- ROSENBLUM, I. M. & BASILE, D. V. (1984). Hormonal regulation of morphogenesis in *Streptocarpus* and its relevance to evolutionary history of Gesneriaceae. *Amer. J. Bot.* 71: 52-64.
- SARGANT, E. (1903). A theory of the origin of monocotyledons, founded on the structure of their seedlings. *Ann. Bot.* 17: 1-92.
- SCHENK, W. (1942). Morphologisch-anatomische Untersuchungen an der Gattung *Streptocarpus* Lindl. *Bot. Arch.* 44: 217-284.
- SHEN-MILLER, J., HINCHMANN, R. & GORDON, S. A. (1968). Thresholds for georesponse to acceleration in gravity-compensated *Avena* seedlings. *Pl. Physiol.* 43: 338-344.
- SIEVERS, A. & HENSEL, W. (1981). Towards a more critical use of clinostats. *Naturwissenschaften* 68: 429.
- SOBICK, V. & SIEVERS, A. (1979). Responses of roots to simulated weightlessness on the fast-rotating clinostat. *Life Sciences and Space Research* 17: 285-290.
- THIMANN, K. V. (1968). Biosatellite II experiments: preliminary results. *Proc. Natl. Acad. Sci. U.S.A.* 60: 347-361.
- TSUKAYA, H. (1997). Determination of the unequal fate of cotyledons of a one-leaf plant, *Monophyllaea*. *Development* 124: 1275-1280.
- WEBER, A. (1975). Beiträge zur Morphologie und Systematik der Klugieae und Loxonieae (Gesneriaceae). I. Die Sproß- und Infloreszenzorganisation von *Monophyllaea* R. Br. *Bot. Jahrb. Syst.* 95: 174-207.
- WEBER, A. (1978). Beiträge zur Morphologie und Systematik der Klugieae und Loxonieae (Gesneriaceae): VII. Sproß-, Infloreszenz- und Blütenbau von *Rhynchoglossum*. *Bot. Jahrb. Syst.* 99: 1-47.
- WEBER, A. & KIEW, R. (1984). Gesneriads of Peninsular Malaysia. *Nature Malaysiana* 8: 24-31.

*An invited contribution to the Festschrift for B.L. Burt's ninetieth birthday*